



Part no.	311-4141100-008
Product name	機器說明書/ GlucoRx Nexus mini ultra /英(DIME)
Spec	L297*W420mm/3折/銅版紙100P/雙面/黑
Designer	JF
Color	 K100  K75



OWNER'S BOOKLET

IMPORTANT SAFETY INSTRUCTIONS

Read Before Use

Dear owner of GlucoRx Nexus mini ultra Blood Glucose Monitoring System, The system consists of three main products: the meter, test strips and control solution. These products have been designed, tested, and proven to work together as a system to produce accurate blood glucose test results. Only use GlucoRx Nexus test strips and control solutions with the GlucoRx Nexus mini ultra Blood Glucose Monitoring System.

Intended Use

This system is intended for external use (*in vitro* diagnostic use) only. It is used for the quantitative measurement of glucose in samples of fresh capillary whole blood taken from the palm, forearm, or fingers. It is not intended to diagnose or screen for diabetes mellitus, or to be used on newborn babies.

Professionals may test with capillary and venous blood sample; home use is limited to capillary whole blood testing.

This system provides you with plasma equivalent results.

APPEARANCE AND KEY FUNCTIONS OF THE METER

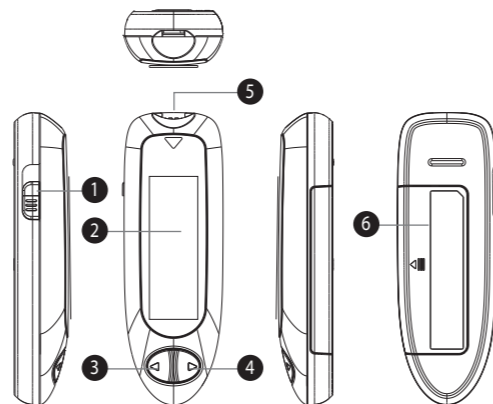

- 1 Test Strip Ejector**
Eject the used strip by pushing up this button.
- 2 Display Screen with White Backlight**
- 3 Down Button (▼)**
- 4 Up Button (▲)**
- 5 Test Strip Slot / Strip Cable Slot**
Insert test strip here to turn the meter on for testing.
- 6 Battery Compartment**

NOTE

The meter will turn off automatically after 120 seconds without any action, or you can press and hold ▲ and ▼ to turn off the meter.

METER DISPLAY

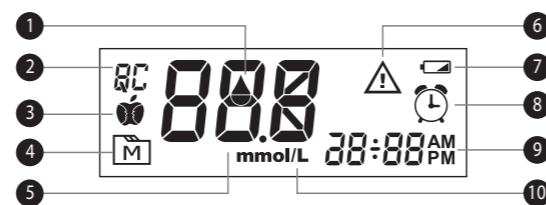

- 1 Blood Drop Symbol**
- 2 Measuring Mode**
- 3 AC/PC Indicator**
- 4 Memory Symbol**
- 5 Test Result**
- 6 Error Message**
- 7 Low Battery Symbol**
- 8 Alarm Symbol**
- 9 Time Display**
- 10 Measurement Unit**

GlucoRx Nexus TEST STRIPS

Your system measures the amount of sugar (glucose) in whole blood. Blood is applied to the absorbent hole on the test strip and is automatically drawn into the reaction cell where the reaction takes place.

The test strip consists of the following parts:

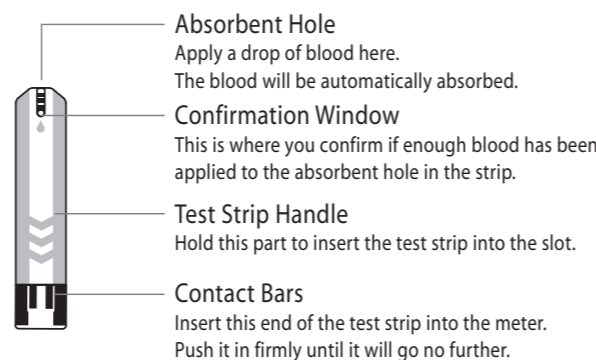

SETTING THE METER

Start with the meter off (no test strip inserted). Press and hold ▲ and ▼ at the same time.

STEP 1. Set the date

With the year flashing, press ▲ until the correct year appears. Press ▼.



With the month flashing, press ▲ until the correct month appears. Press ▼.



With the day flashing, press ▲ until the correct day appears. Press ▼.



STEP 2. Setting the time format.

Press ▲ to select the desired time format -- 12h or 24h.
Press ▼.

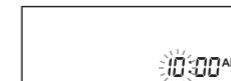

STEP 3. Set the hour and minute

With the hour flashing, press ▲ until the correct hour appears. Press ▼.
With the minute flashing, press ▲ until the correct minute appears. Press ▼.

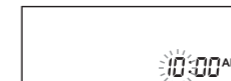

STEP 4. Setting the buzzer beep

Press ▲ to switch between buzzer beep on or off.
Press ▼.



STEP 5. Setting the reminder alarm

Your meter has four reminder alarms. The meter will display "OFF", "AL1" and "AL2". If you don't want to set an alarm, press ▲ to select "OFF", and then press ▼ to skip this step. Or select "On" and press ▼ to proceed.

With the hour/minute flashing in sequence, press ▲ to select the correct hour/minute. Press ▼ and go to the next alarm setting.

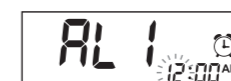

THE FOUR MEASURING MODES

The meter provides you with four modes for measuring: General, AC, PC and QC.

MODES	USE WHEN
General	any time of day, regardless of time since last meal
AC	no food intake for at least 8 hours
PC	2 hours after a meal
QC	testing with the control solution

You can switch between each mode by:

1. Start with the meter switched off. Insert a test strip to turn on the meter. The screen will display "▲".

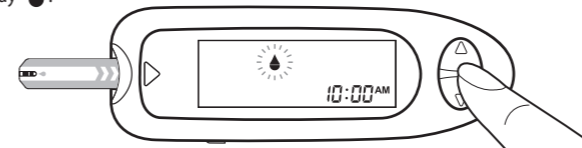

2. Press ▲ to switch between General, AC, PC and QC mode.

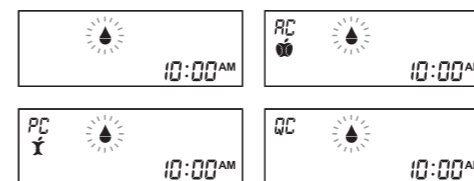

CHECKING THE SYSTEM WITH CONTROL SOLUTION

Our control solution contains a known amount of glucose that reacts with test strips. By comparing the result of your control solution test with the expected range printed on the test strip vial label, you can check that the meter and test strips are working together as a system and that you are performing the test correctly. It is very important that you perform this simple check routinely to make sure you get accurate results.

HOW TO PERFORM A CONTROL SOLUTION TEST

STEP 1. Insert test strip

Insert a test strip into the test slot with the contact bars end first and facing up. (Contact bars must be inserted all the way into the meter or you may get an inaccurate test result.) The meter turns on automatically and displays the following in sequence:

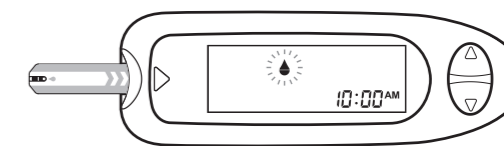

When the "▲" symbol appears on the display, press ▲ and "QC" will appear on the display. When the "QC" sign is displayed, the meter will not store your test result in the memory. If you decide not to perform a control solution test, press ▲ again and the "QC" sign will disappear.

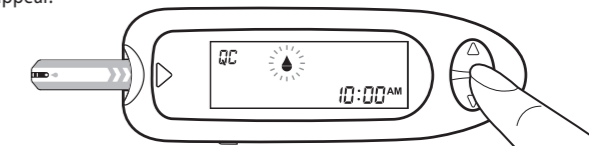

CAUTION

Every time you perform a control solution test you must enter "QC" test mode so that the test result will not be stored in the meter memory.

STEP 2. Apply control solution

Shake the control solution vial thoroughly before use. Squeeze out a drop and wipe it off, then squeeze out another drop and place it on the tip of the vial cap. Hold the meter to move the absorbent hole of the test strip to touch the drop. Once the confirmation window fills completely, the meter will begin counting down. To avoid contaminating the control solution, do not directly apply control solution onto a strip.

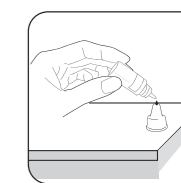

STEP 3. Read and compare the results

After the meter counts to 0, the result of the control solution test will appear. Compare the result with the range printed on your test strip vial. The result should fall within this range.



Out-of-range results

If you continue to have test results falling outside the range printed on the test strip vial, your meter and/or strips may not be working properly. Do NOT test your blood. Contact GlucoRx Customer Services on 01483-755133.

TESTING YOUR BLOOD

Preparing the Lancing Device for Blood Testing

Please follow the instructions in the lancing device insert for collecting a blood sample. Never share a lancet of the lancing device. GlucoRx Lancing device is for **self-use only**.

STEP 1. Insert the test strip to turn on the meter

Wait for the meter to display "▲".

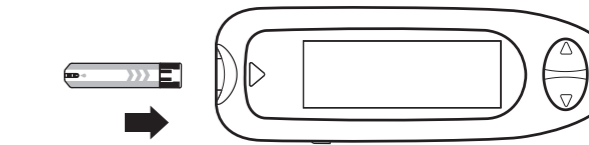

STEP 2. Select the appropriate measuring mode by pressing ▲

For selecting the measurement mode, please refer to the "FOUR MEASURING MODES".

STEP 3. Apply blood sample

Wipe the first drop off and obtain a drop of blood of at least 0.5 µL using the GlucoRx lancing device. Use the clear cap for sites other than fingers and refer to the strip package insert for more details.

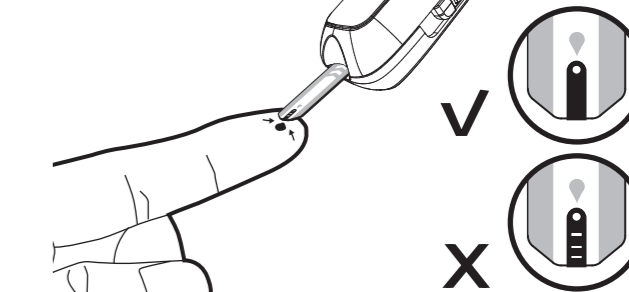

[Dealer's Portion]

WARRANTY REGISTRATION CARD



Product Name: _____

Owner's Name: _____

Address: _____

Tel No: (M) _____ (H) _____ (W) _____

Email: _____

Date of Birth: _____ Gender: M F

Blood glucose testing frequency: _____

Insulin dependent? _____

Date obtained: / / Serial No: _____

GP Surgery name and Address: _____

*IMPORTANT: To qualify for the warranty, please fill in this card and mail to us within 6 months from date product obtained.

[Owner's Portion]



WARRANTY CERTIFICATE

Product Name: _____

Owner's Name: _____

Address: _____

Tel No: (M) _____ (H) _____ (W) _____

Email: _____

Date of Birth: _____ Gender: M F

Blood glucose testing frequency: _____

Insulin dependent? _____

Date obtained: / / Serial No: _____

GP Surgery name and Address: _____

*NOTE: Please produce this card for warranty service.

Gently apply a drop of blood to the absorbent hole of the test strip at a titled angle. The confirmation window should be completely filled if enough blood sample has been applied. Do **NOT** remove your finger until you hear a beep sound or a count down starts.

If the confirmation window is not filled completely before your meter begins to count down, do not add more blood to the test strip. Discard the test strip and start again. If you have trouble filling the test strip, please call GlucoRx Customer Services on 01483-755133 for assistance.

NOTE

If you do not apply a blood sample within 2 minutes, the meter will turn itself off. You must remove the test strip and insert it back into the meter to restart the test.

STEP 4. Get result

Your blood glucose result will be stored in the memory automatically.



Warning

1. Please do not change your treatment based on the result without first consulting your healthcare professional.
2. Turn the meter off by removing the test strip. Discard the used test strip and lancet carefully according to your local regulations.

ALTERNATIVE SITE TESTING

You can test on a variety of locations on your body.

Important: There are limitations with AST (Alternative Site Testing). Please consult your healthcare professional before you perform AST.

When to use AST?

Food, medication, illness, stress and exercise can affect blood glucose levels. Capillary blood at the fingertip reflects these changes faster than capillary blood at other sites. Thus when testing blood glucose during or immediately after a meal, physical exercise or any other event, take a blood sample from your finger only.

We strongly recommend that you perform AST ONLY at the following times:

- In a pre-meal or fasting state (more than 2 hours since the last meal).
- Two hours or more after taking insulin.
- Two hours or more after exercise.

Do NOT use AST if:

- You think your blood glucose is low.
- You are unaware of hypoglycemia
- You are testing for hyperglycemia
- Your AST results do not match the way you feel.
- Your routine glucose results often fluctuate.

VIEWING THE METER MEMORY

Viewing Results

Your Meter stores the 1000 most recent blood glucose test results with date and time in its memory. You can review the test results with these easy steps.

STEP 1. Enter the memory mode

With the meter turned off, press and release ▲. The first reading you see is the last blood glucose result along with date, time and the measuring mode.



When using your meter for the first time "----" will appear, indicating that there are no test results in the memory.

STEP 2. Recall test results

Press ▲ or ▼ to review your last 1000 test results in order. When the memory is full, the oldest result will be replaced by the newest test result.



STEP 3. Exit the memory mode

Press ▲ and ▼ together to turn off the meter.

NOTE

The results of control solution tests are **NOT** stored in the memory. Stored results are blood glucose results only.

Reviewing Blood Glucose Day Average Results

1. Press and release ▼.

With the meter turned off, press and release ▼. Your 7-day average result measured in general mode will appear on the display.



2. Press ▲ or ▼ to review 14-, 21-, 28-, 60- and 90- day average results stored in each measuring mode in the order of Gen, AC, then PC.

3. Exit the meter memory.

Keep pressing ▲ and ▼ together and the meter will be turned off.

NOTE

- Anytime you wish to exit the memory, keep pressing ▲ and ▼ together or leave it without any action for 2 minutes. The meter will switch off automatically.
- Control solution results are NOT included in the day average.
- If using your meter for the first time, "----" displays when you recall the test results or review the average result. It indicates that there is no test result in the memory.

DOWNLOADING RESULTS ONTO A COMPUTER

You can use the meter with a strip port cable and the GlucoRx Healthcare Software System to view your test results on a personal computer. To learn more about the GlucoRx Healthcare Software System or to obtain a strip port cable separately, please contact GlucoRx customer services by calling 01483 755133.

1. Obtaining the required cable and installing the software

To download the GlucoRx Healthcare Software System, please visit GlucoRx website at www.glucoRx.co.uk.

2. Connecting to a personal computer

With the meter switched off, connect the strip port cable from your meter to a cable port on your computer. "PC" will appear on your meter display, indicating that the meter is in communication mode.

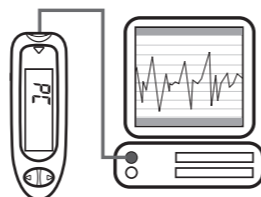

3. Data transmission

To transmit data, follow the instructions provided with the software. Results will be transmitted with the date and time. Remove the cable and the meter will automatically switch off.

Warning

While the meter is connecting to the PC, it is unable to perform a blood glucose test.

REPLACING THE BATTERY

Your meter comes with one 1.5V AAA size alkaline battery. If the low battery symbol "⎓" appears on the screen, this indicates that the battery is low and it is time to replace the battery.

1. Press the edge of the battery cover and lift it up.
2. Remove the old battery and replace with one 1.5V AAA size alkaline battery.
3. Close the battery cover. If the battery is inserted correctly, you will hear a "beep" afterwards.

NOTE

- Replacing the battery does not affect the test results stored in the memory.
- As with all small batteries, these batteries should be kept away from small children. If swallowed, promptly seek medical assistance.
- Battery may leak chemicals if unused for a long time. Remove the battery if you are not going to use the device for an extended period (i.e., 3 months or more).
- Properly dispose of the battery according to your local environmental regulations.

DISPLAY MESSAGES AND PROBLEM-SOLVING GUIDE

The following is a summary of display messages. If your meter displays an error message, please follow the actions for the error message as described in the table below. If the problem persists, please contact GlucoRx for help.

MESSAGE	WHAT IT MEANS
Lo	<1.1 mmol/L
Li	1.1 - 33.3 mmol/L
Hi	>33.3 mmol/L

MESSAGE	WHAT IT MEANS	ACTION
E-b	The ⎓ symbol appears with this message. This means that the battery does not have enough power for a test.	Replace the battery immediately.
E-U	A used test strip is inserted, or there is an electrical problem.	Repeat test with a new test strip. If the error message re-appears, please contact GlucoRx for help.
E-t	The temperature of the environment, meter, or test strip is outside the system's operating range. You cannot perform a test until the meter and test strip are within the operating range of 10°C to 40°C (50°F to 104°F).	Repeat the test after the meter and test strip are within the operating temperatures.
E-E	Problem with the meter.	Review the instructions and try again with a new test strip. If the problem persists, please contact GlucoRx for help.
E-D		
E-R		
E-C		
E-F	You may have removed the strip after applying blood to the absorbent hole.	Keep the test strip in the meter after it has absorbed the blood until the meter displays the test result.

For questionable results, please see test strip package insert for important information.

SYMBOL INFORMATION

Symbol	Referent	Symbol	Referent
IVD	In vitro diagnostic medical device	Manufacturer	Manufacturer
Instructions	Consult instructions for use	SN	Serial number
Temperature	Temperature limitation	EC REP	Authorised representative in the European Community
Use by	Use by	LOT	Batch code

CARING FOR YOUR METER

Cleaning

1. To clean your meter exterior, wipe it with one disinfecting wipe (Example: Micro-Kill Plus™) to clean exposed surfaces thoroughly and remove any visible dirt, blood or any other body fluid with the wipe. Then dry the device with a soft, dry and clean cloth.

2. Do NOT rinse the meter with water.

Meter Storage

- Storage conditions: -20°C to 60°C (-4°F to 140°F), below 95% relative humidity.
- Always store or transport the meter in its original carry case.
- Avoid dropping and heavy impact.
- Avoid direct sunlight and high humidity.

Meter Disposal

The used meter should be treated as contaminated that may carry a risk of infection during measurement. The batteries in this used meter should be removed and the meter disposed in accordance with local regulations. The meter falls outside the scope of the European Directive 2002/96/EC-Directive on waste electrical and electronic equipment (WEEE).

SPECIFICATIONS

Model no.: TD-4141
 Dimensions: 97.8 (L) x 33.5 (W) x 18 (H) mm
 Weight: 30g
 Power source: One 1.5V AAA alkaline battery
 Display: LCD
 Memory: 1000 non-deletable memory sets with date and time
 Automatic detection of electrode insertion
 Automatic reaction time count-down
 Automatic blood detection
 Temperature warning
 Operating conditions: 10°C to 40°C (50°F to 104°F), below 85% R.H.
 Meter storage/transport conditions: -20°C to 60°C (-4°F to 140°F), below 95% R.H.
 Strip storage/transport conditions: 2°C to 32°C (35.6°F to 89.6°F), below 85% R.H.
 Measurement units: Fixed mmol/L
 Measurement range: 1.1-33.3 mmol/L
 Expected service life: 5 years

This device has been tested to meet the electrical and safety requirements of: IEC/EN 61010-1, IEC/EN 61010-2-101, EN 61326-1, IEC/EN 61326-2-6.

Distributed by GlucoRx Ltd
 4 Wintonlea, Monument Way West
 Woking, Surrey, GU21 5EN, UK
 Website: www.glucoRx.co.uk
 Customer care line: 01483 755133

TaiDoc Technology Corporation
 B1-7F., No. 127, Wugong 2nd Rd., Wugu Dist.,
 New Taipei City 248, Taiwan (R.O.C.)
www.taidoc.com

MedNet GmbH
 Borkstraße 10, 48163 Münster, Germany



Please cut off this 'Dealer's portion' of the Warranty Registration Card, insert it in an envelope and post to:

GlucoRx Ltd
4 Wintonlea, Monument Way West,
Woking, Surrey, GU21 5EN, UK

TERMS & CONDITIONS OF WARRANTY



1. GlucoRx warrants this product to be free of defects in workmanship and materials within the said warranty period on the Warranty Certificate.
2. During the warranty period if this product is found to be defective, you may send it with the Warranty Certificate to our office for warranty service. GlucoRx will then repair or replace defective parts, or exchange the whole product as GlucoRx may choose, with no additional charge to the original owner. After such repair, replacement or exchange, the product will be warranted for the remaining time of the warranty period.
3. This warranty is valid only if the Warranty Certificate and Warranty Registration Card are duly completed with date of obtaining product, serial number and if the Warranty Registration Card is sent to our office (or you register on our website www.glucoRx.co.uk) no later than 6 months from the date obtained.
4. This warranty is void if this product has been repaired or serviced by an unauthorised person. This warranty does not cover defects caused by misuse, abuse, accident, tampering, lack of reasonable care, fire or any other acts beyond human control.
5. Except as stated in the above paragraphs, GlucoRx disclaim all other warranties, including those of merchantability of fitness for a particular purpose with respect to the use of this product. GlucoRx shall not be liable for any direct, consequential or incidental damages arising out of the use or inability to use this product.